

USG BORAL DRYWALL PARTITIONS INSTALLATION GUIDE

1- How to Build with Steel Stud and Track

Attach track to floor and ceiling

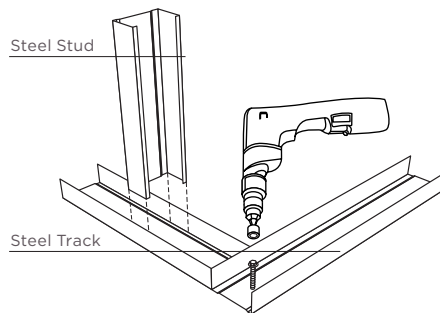

Screw lengths of track to the floor and ceiling.

Tracks are slightly wider than studs, so studs snap right in.

Use straight snips for cutting

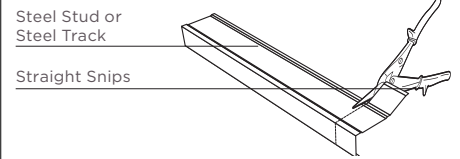

To trim to correct length, cut both side flanges of a steel stud, using straight-cut aviation snips. Then bend one flange up and cut across the stud's web.

Screw stud to track

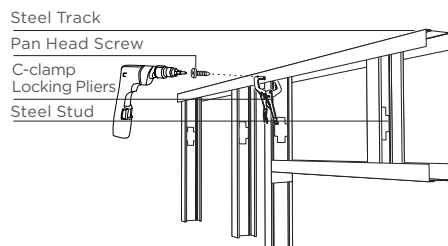

Join studs to tracks by clamping the two members tightly with a C-clamp locking pliers and driving a pan-head screw in the middle where they meet.

- Drive the screws at medium speed.
- Choose a clutch setting strong enough to drive the screw home, but not so strong that it strips the screw hole and weakens the joint.

Use bushings for electric cable

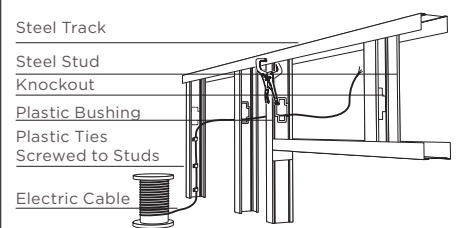

Secure electrical cable along the center line of each stud with plastic ties screwed to the studs. Pop a plastic bushing into each knockout to keep the cable from rubbing against the sharp edges.

- Add wood nailers as needed for doors, windows and cabinets.

- Hang drywall or sheathing using 3.1 cm self-tapping drywall screws spaced every 20.3 cm along edges (where two sheets meet on a stud) and 30.5 cm on center elsewhere.

- Check local building codes. They may require screws placed closer together, and having too many screws is preferable to having to add more after the inspector comes.

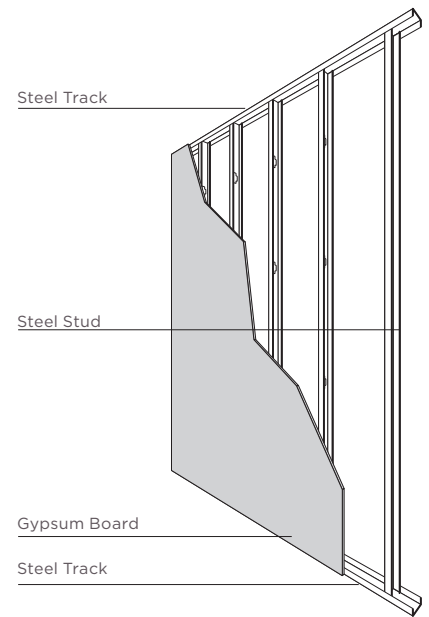

2- Installation- Stud

For standard installation insert the studs into the top and floor tracks and twist to lock as shown.

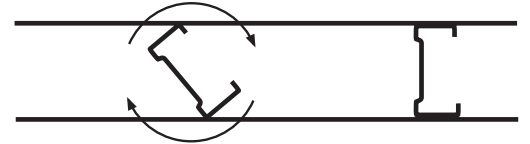

The friction it will hold the stud in place.

- Non-fire rated partitions-allow a 10mm gap between the top of the stud and inside face of the track, as illustrated.

3- Safety First

- Don't try nailing trim into steel studs. It will not hold. Instead, use specially designed trim screws for the job.

- Cut steel is sharp—wear gloves.

- Always wear eye protection when cutting steel and when driving screws. A screw may jump off the power screwdriver and can cause eye injuries.

- Make sure that architect's or designer's plans aren't drawn for wood dimensions.

4- Installation Plasterboard to Stud

To attach plasterboard to light gauge steel studs, a slightly different technique is required compared to conventional timber studs. Use the following instructions to ensure correct installation.

Correct Method

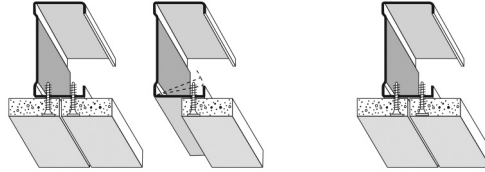

As the face of a steel stud can deflect initially, using the correct sequence to attach the board is important. Attach the first board to the open side of the stud. The face will deflect slightly, then will pull tight against the board. Support the stud to avoid twisting and fully screw the board to this stud before continuing. The next sheet can now be screwed to the closed side of the stud. Deflection will be minimal as the first sheet helps keep a rigid assembly and the result is a correct at joint.

Incorrect Method

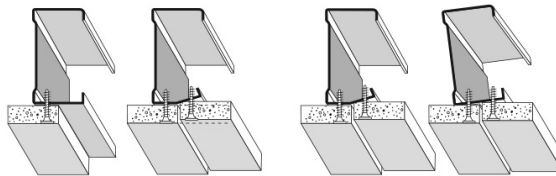

If a board is screwed to the closed side first, then the face is able to deflect when the next board is screwed to the open side. This can permanently bend the face, resulting in a lipped joint.

Plasterboard Fixing Sequence

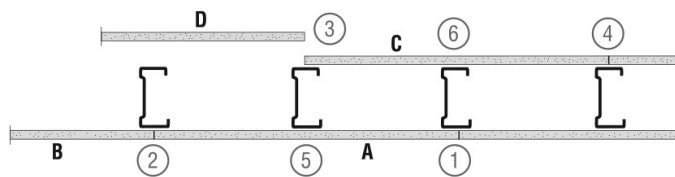

The boards shall be fixed in the sequence shown A B C D. When installing the first side (A and B), fasten the board at the edges only (1 & 2). The centre must not be fastened until the second side (C & D) have been installed. Locate board joints on each side of the wall on alternate studs.

Screws shall be fastened in sequence 1-6. Correct sequence will minimize any misalignment problems and result in a higher quality finish.

5- Installation Details

Spliced Studs

When heights greater than standard pre-cut lengths are required, using the 'boxing' feature single studs can be spliced together to extend to the required height. Minimum overlap: 3 x depth of stud, for example,

- 98.8 mm stud = 300 mm overlap
- 63.8 mm stud = 200 mm overlap
- Rivets: 4 mm dia. mild steel, 3 per face (total 6)
- Splice must be within 25% of wall height, and splices should be alternated top and bottom. Splices may be used in fire rated walls, provided steel rivets are used (not aluminium).

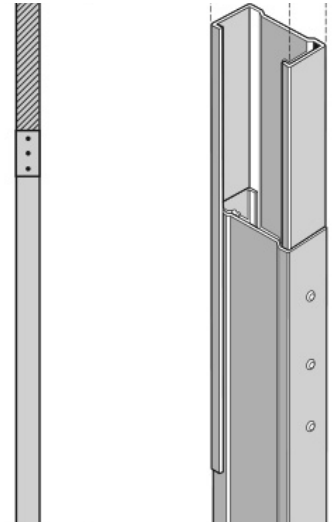

6- Nogging

Single Nogging

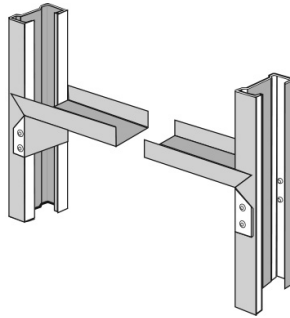

Where specific load requirements or fixtures are needed, an individual nog can be formed from the track profile to fit between the studs. Cut and trim as shown and fix with 3 mm diameter rivets. The maximum height tables do not allow for heavy loads to be attached to the walls such as TV's, cantilevered benches / bookcases/ toilets etc. Where such equipment must be hung off a wall, specifically designed supports are required.

Please contact USG Boral Interiors for this assistance.

Continuous Nogging

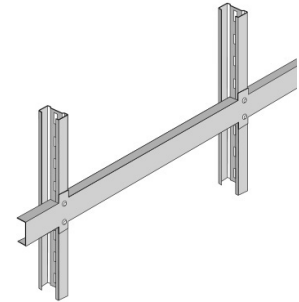

For certain applications such as towel rails, pictures and suspended ceiling perimeter fixing etc, continuous nogging may be required. Use the track, cut, notch and fix as shown. This will normally link 5-6 studs at 600 mm centres. Double sided can also be achieved if required by repeating on the other stud face.