

# ECOFELT

ACOUSTICAL PET FELT PANELS

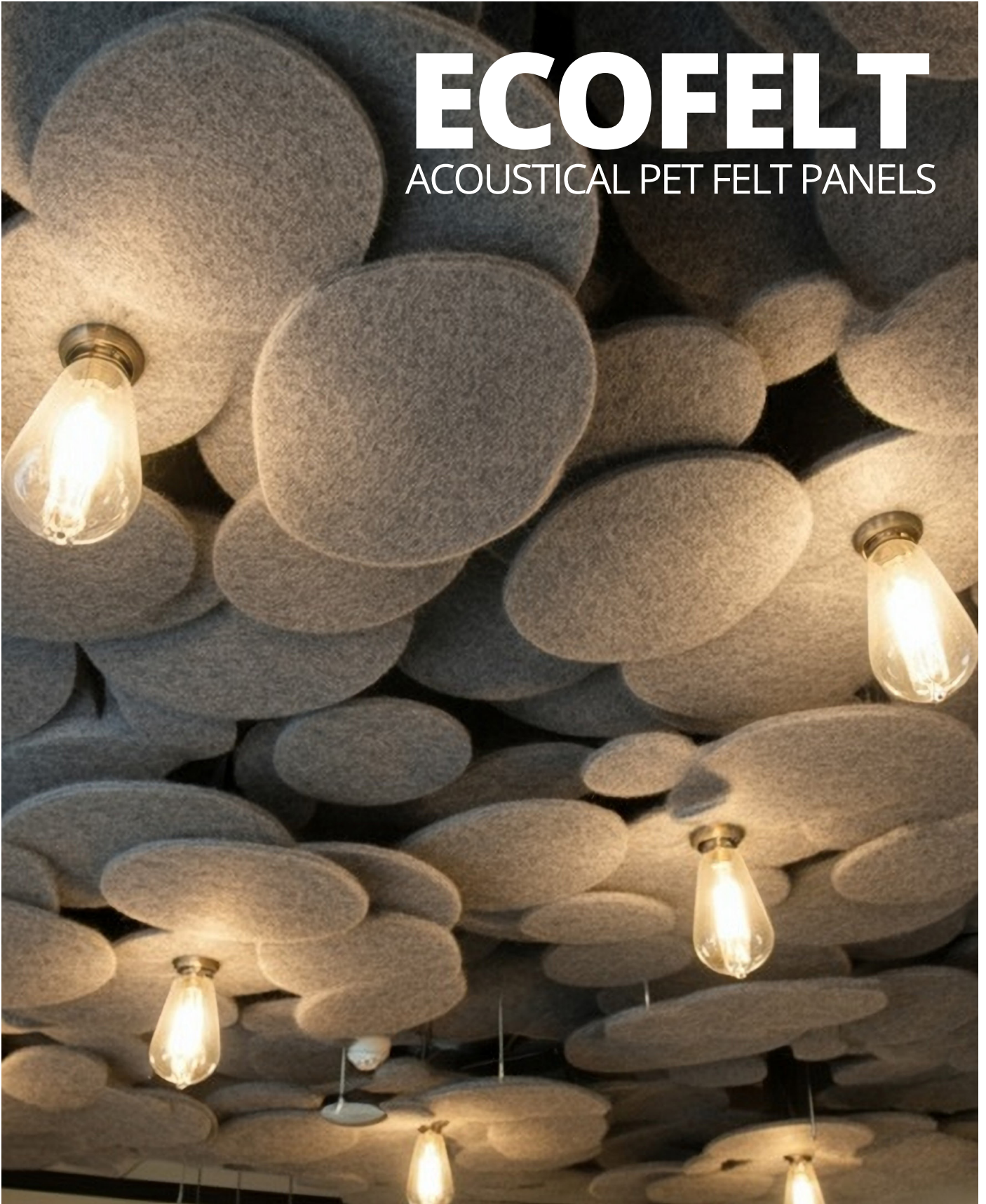

2026  
V1

[WWW.USGME.COM](http://WWW.USGME.COM)

**USG ME** <sup>TM</sup>  
INNOVATIVE SOLUTIONS. EVERYTIME.



# *ECOFELT:* DESIGNED TO IMPRESS

USG Middle East introduces its latest innovation:  
The ECOFELT Acoustical PET Felt Collection.  
This collection showcases a diverse range of designs, catering to various aesthetic  
preferences and architectural styles.



# WWW.USGME.COM



VISIT USG MIDDLE EAST'S WEBSITE FOR NEW SYSTEM DESIGNS, SOLUTIONS, AND LATEST PRODUCT OFFERINGS. NOW YOU CAN PLAN AND VISUALIZE YOUR PROJECT, GET A QUOTE, AND PLACE YOUR SAMPLE ORDER THROUGH USGME.COM

Visit USG Middle East's social media and digital platforms to stay updated on all our solutions and designs. Follow us on:



SEE US ON LINKEDIN  
/usgme



FOLLOW US ON X  
/usg\_me



FIND US ON FACEBOOK  
/usgme



SEE US ON YOUTUBE  
/USG Middle East



FOLLOW US ON INSTAGRAM  
/usg\_me



MESSAGE US ON WHATSAPP  
/+966 92 003 5672



# ECOFELT

ACOUSTICAL PET FELT PANELS

RIBPANEL SYSTEM



CANOPY SYSTEM

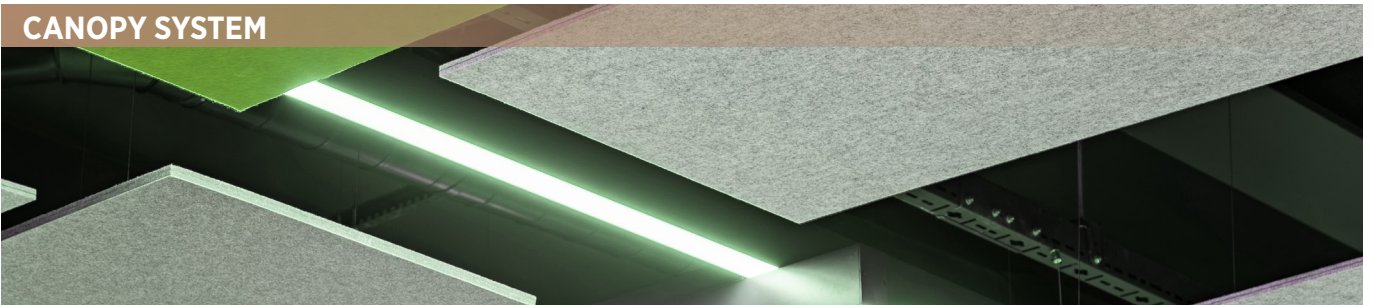

BAFFLES SYSTEM



PETWAVES SYSTEM

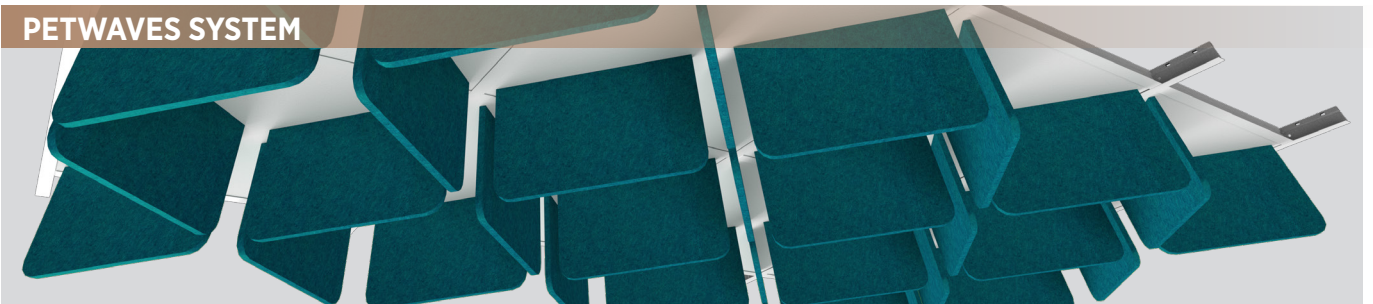

WALL SYSTEM

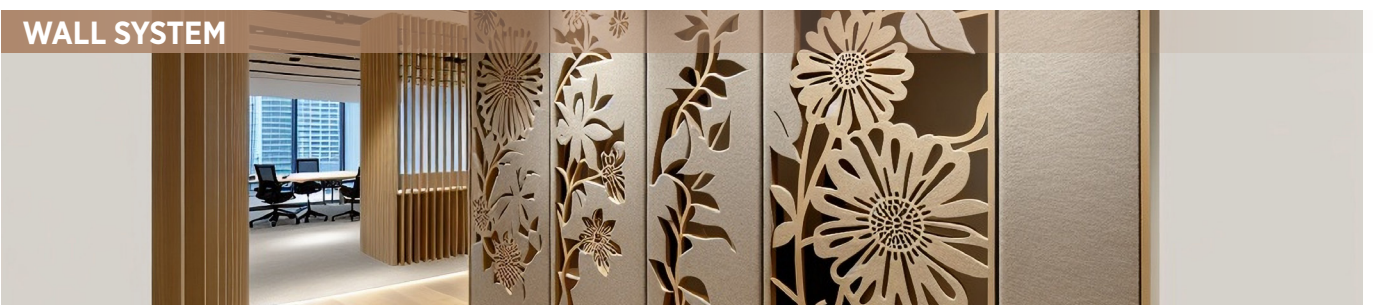

# ECOFELT

## PET FELT ACOUSTIC PANELS



ECOFELT ACOUSTIC PANELS

### FEATURES AND BENEFITS

- Panels offer budget-friendly and lightweight base panels.
- High sound-absorbing materials provide excellent acoustic performance.
- Panels are available in natural color, veneer laminated, HPL laminated, and inkjet printed finishes to suit various styles.
- Can be used for wall covering, ceiling tiles, canopies, baffles, and special design installations.
- Panels made of PET Felt up to 100% post-consumer recycled polyester material contribute to sustainability, using recycled materials for a greener option.
- Available in custom sizes and designs. Mix and match to get any color combination.
- Panels are easy to clean and maintain.

### APPLICATIONS

- Open-Plan Offices
- Airports
- Train & Metro Stations
- Public Concourses & Transportation Hubs
- Restaurants & Cafés
- Auditoriums & Concert Halls
- Museums & Cultural Venues
- Libraries
- Fitness Centers & Gyms



AVAILABLE FINISHES



Natural Colors

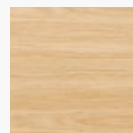

Veneer and HPL Laminated



Inkjet Printed

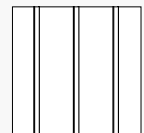

Slotted

### CANOPIES DESIGN



### BAFFLES DESIGN



### WALL DESIGN



### WALL MOUNTING DESIGN

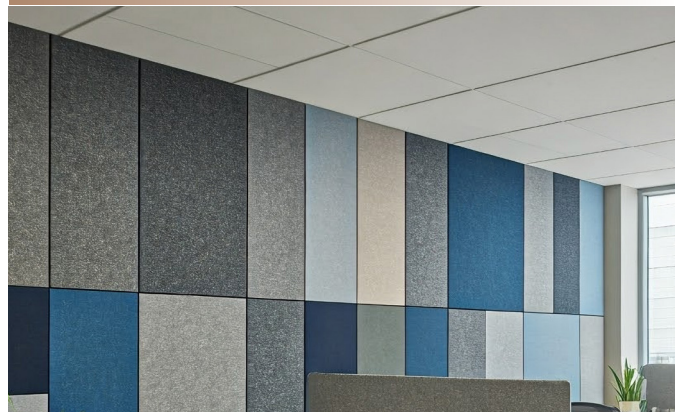

## SPECIFICATION DETAILS

#### PHYSICAL CHARACTERISTICS:

##### ASTM E1264 Classification

Type I, Pattern G

##### Substrate

100% polyester fibers with recycled content

##### Panel Size

Customizable as per the panel configuration

Max length 3000mm,

Max width 1250mm,

Max thickness 24mm

##### Thickness

3mm, 5mm, 7mm, 9mm, 12mm, 24mm

##### Density

Standard 200-220 kg/m<sup>3</sup>.

Up to 360 kg/m<sup>3</sup> is available upon request

##### Finish

80 standard natural colors.

Veneer laminated.

HPL laminated.

Inkjet printed.

#### ACOUSTIC & COMFORT PERFORMANCE:

##### Noise Reduction Coefficient [NRC]

[0.65 - 0.85] depending on the PET Felt panel thickness

#### HEALTH, SAFETY & SUSTAINABILITY:

##### Surface Burning Characteristics as per ASTM E84

Class A

##### Reaction to Fire as per EN 13501-1

B-s1, d0

##### Recycled Content

Minimum 60%

##### Indoor Air Quality

Low VOC emission, formaldehyde-free, and phenol-free

# ECOFELT

## PET FELT ACOUSTIC PANELS

### RIBPANEL SYSTEM

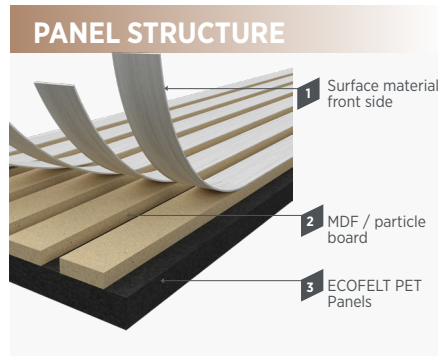
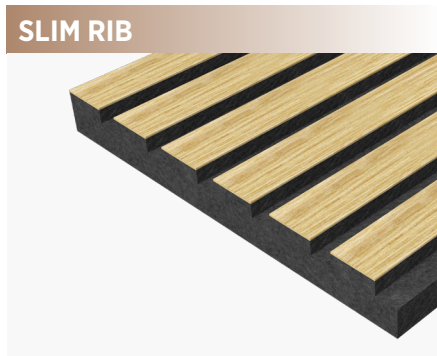
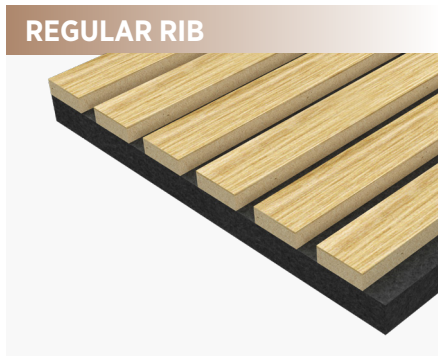

### RIB PANELS PATTERNS

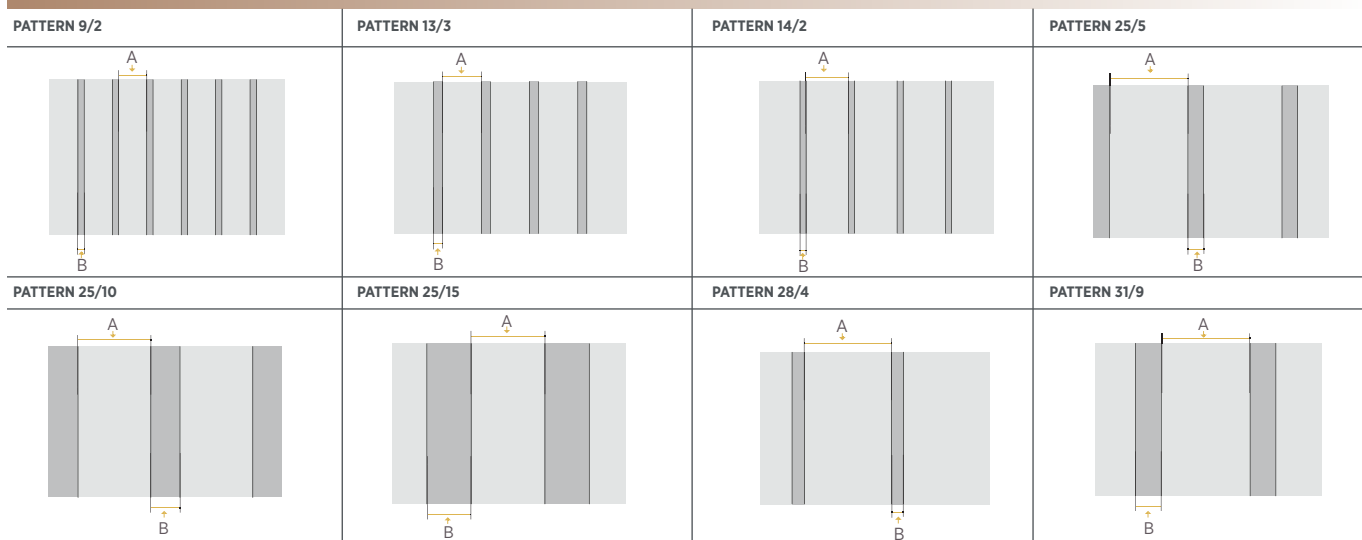

PATTERN	RIB WIDTH(A)	DISTANCE BETWEEN RIBS(B)	$\alpha_w$	NRC
9/2	9mm	2mm	0.65	0.80
13/3	13mm	3mm	0.65	0.80
14/2	14mm	2mm	0.65	0.80
25/5	25mm	5mm	0.65	0.80

PATTERN	RIB WIDTH(A)	DISTANCE BETWEEN RIBS(B)	$\alpha_w$	NRC
25/10	25mm	10mm	0.65	0.80
25/15	25mm	15mm	0.65	0.80
28/4	28mm	4mm	0.65	0.80
31/9	31mm	9mm	0.65	0.80



# ECOFELT

## PET FELT ACOUSTIC PANELS

### CANOPIES SYSTEM

SQUARE

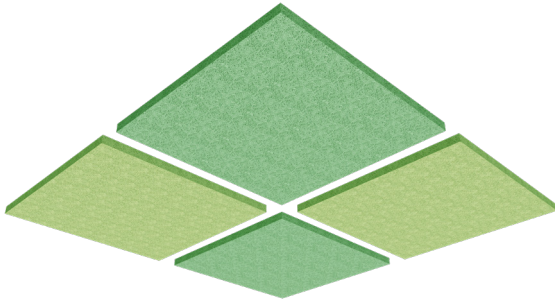

PARALLELOGRAM

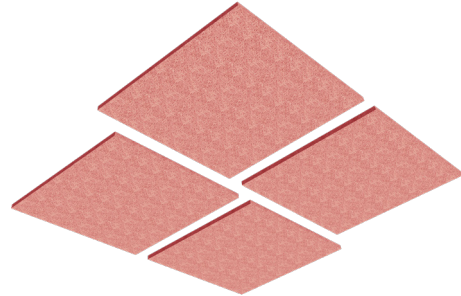

RECTANGLE

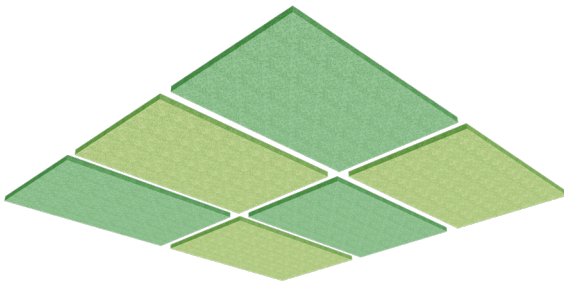

TRAPEZOID

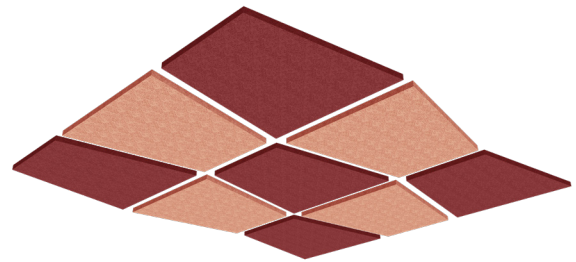

\* Maximum width is 1250mm. Refer to USG Middle East technical team for size limitation and suspension accessories. Other configurations are available upon request.

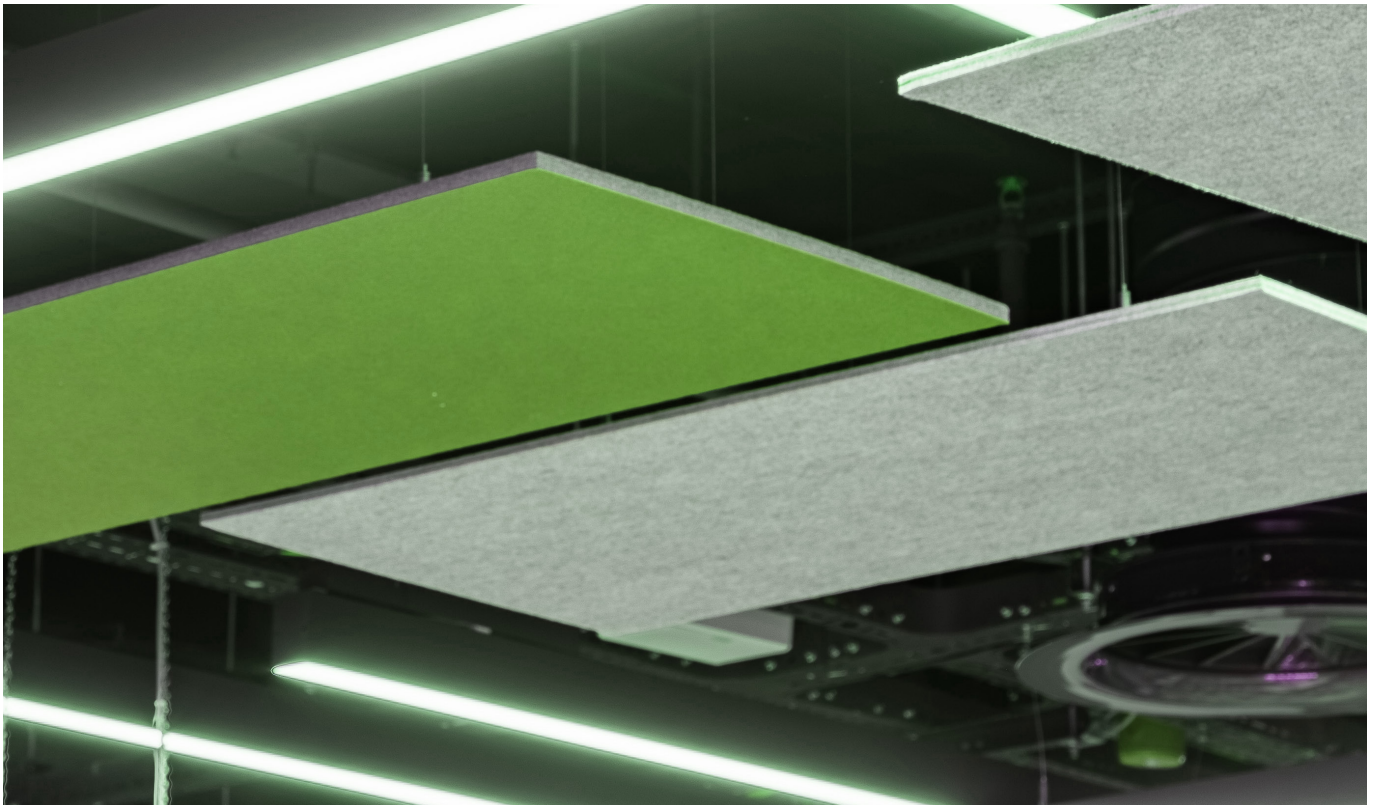

# ECOFELT

## PET FELT ACOUSTIC PANELS

### CANOPIES SYSTEM



HEXAGON

TRIANGLE

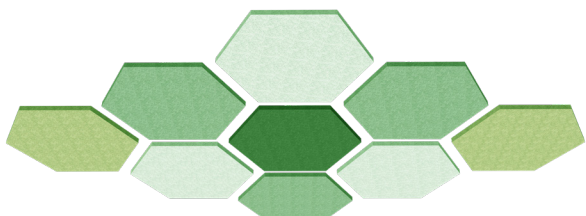

CONCAVE

CONVEX

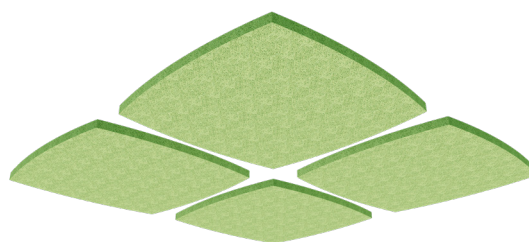
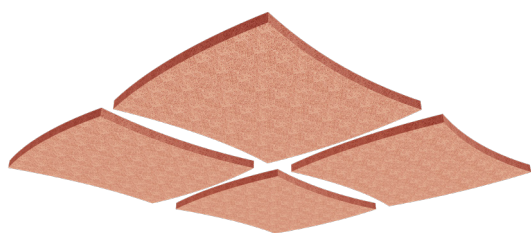

# ECOFELT

## PET FELT ACOUSTIC PANELS

### CANOPIES SYSTEM

CIRCLE

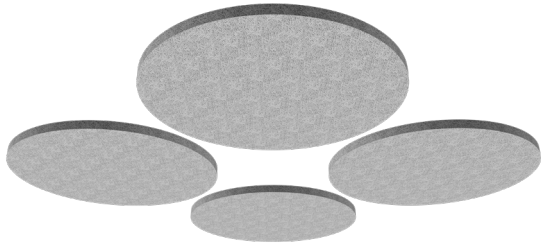

TRAPEZOID

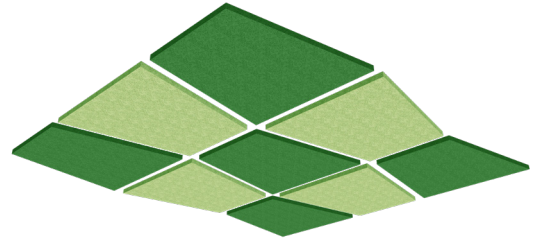

CURVED

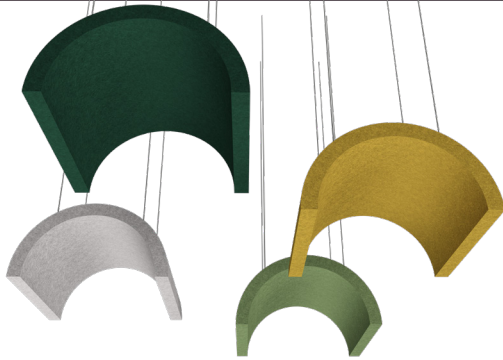

SWING

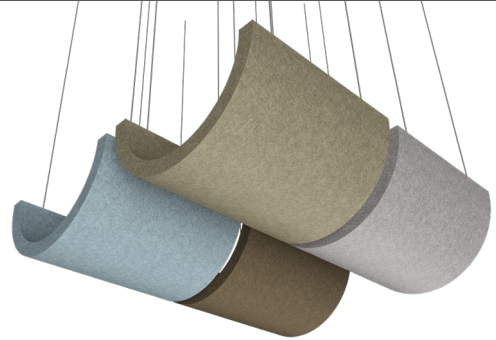

# ECOFELT

## PET FELT ACOUSTIC PANELS

### CANOPIES SYSTEM



BUTTERFLY

CYLINDER

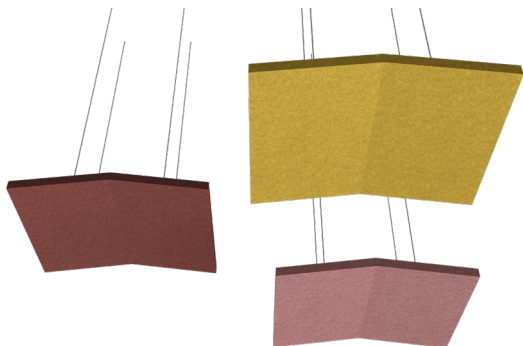

3D CANOPY

PRINTED CANOPY

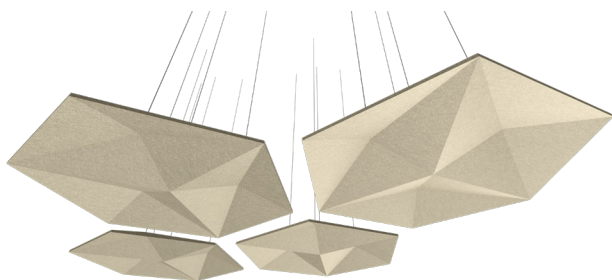

# ECOFELT

## PET FELT ACOUSTIC PANELS

### BAFFLES SYSTEM

LINEAR BAFFLES

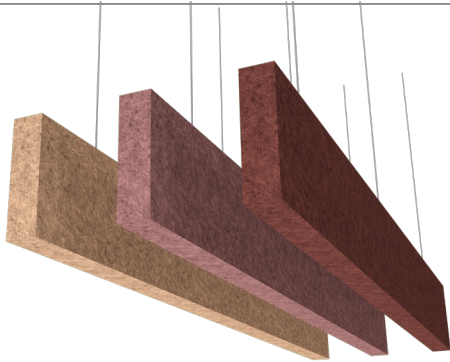

ANGLED BAFFLES

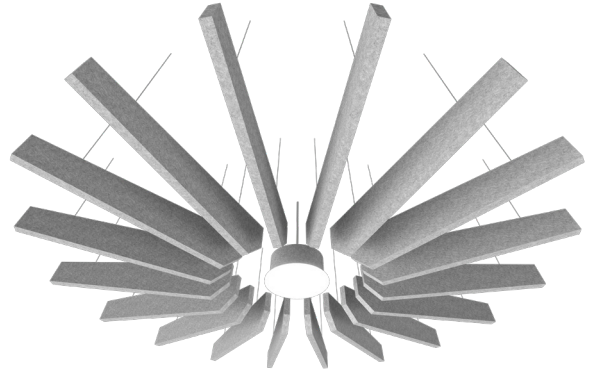

U SHAPE BAFFLES

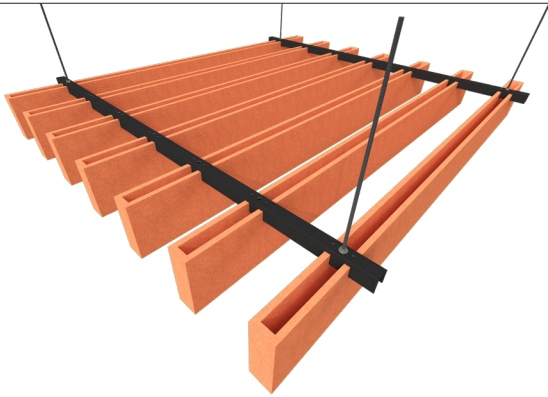

BOX BAFFLES

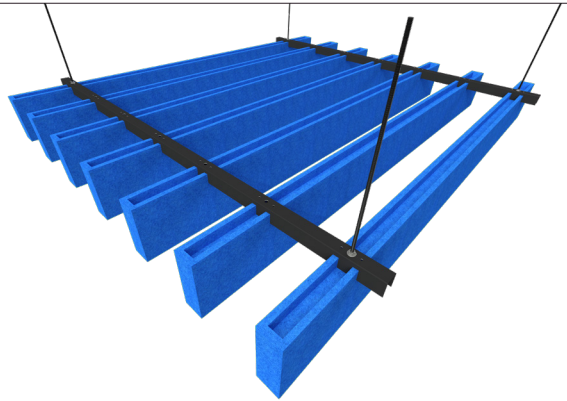

# ECOFELT

## PET FELT ACOUSTIC PANELS

### BAFFLES SYSTEM



WAVES BAFFLES

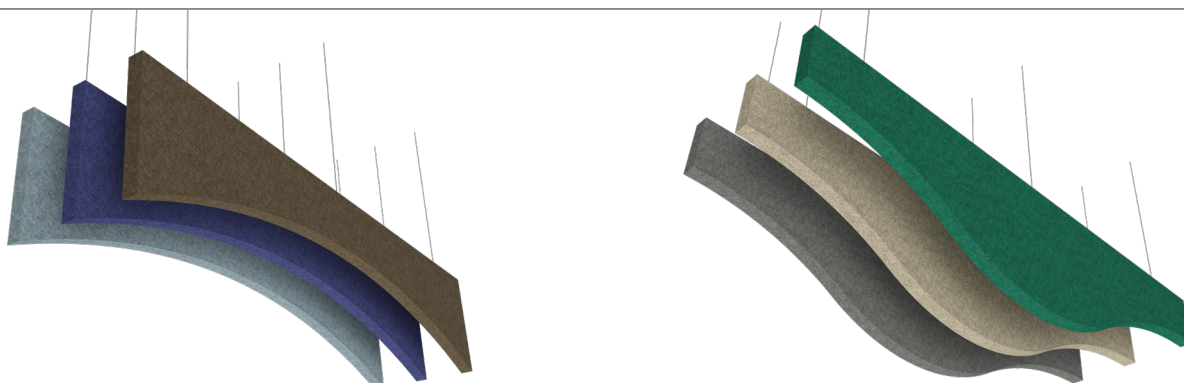

BEAM BAFFLES

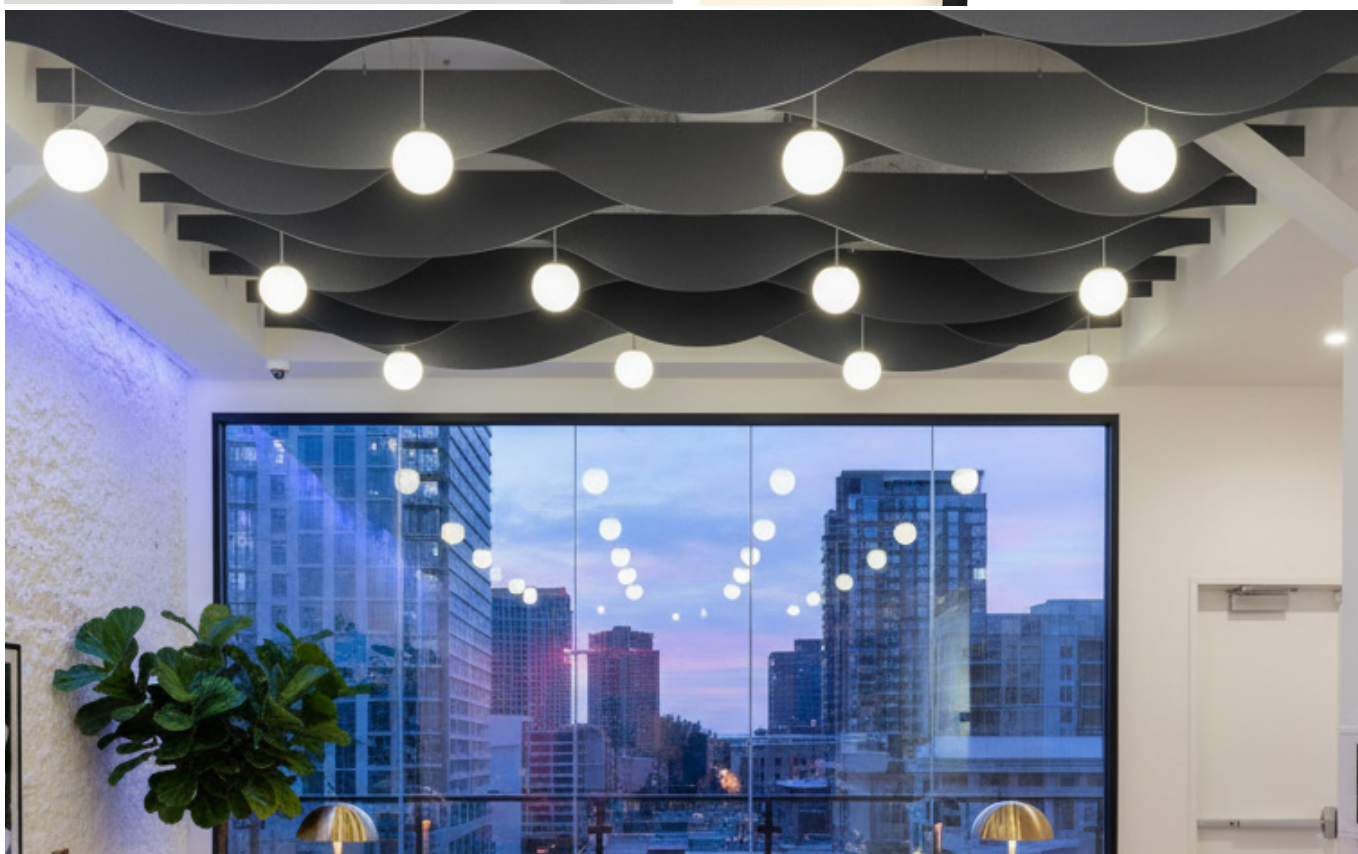
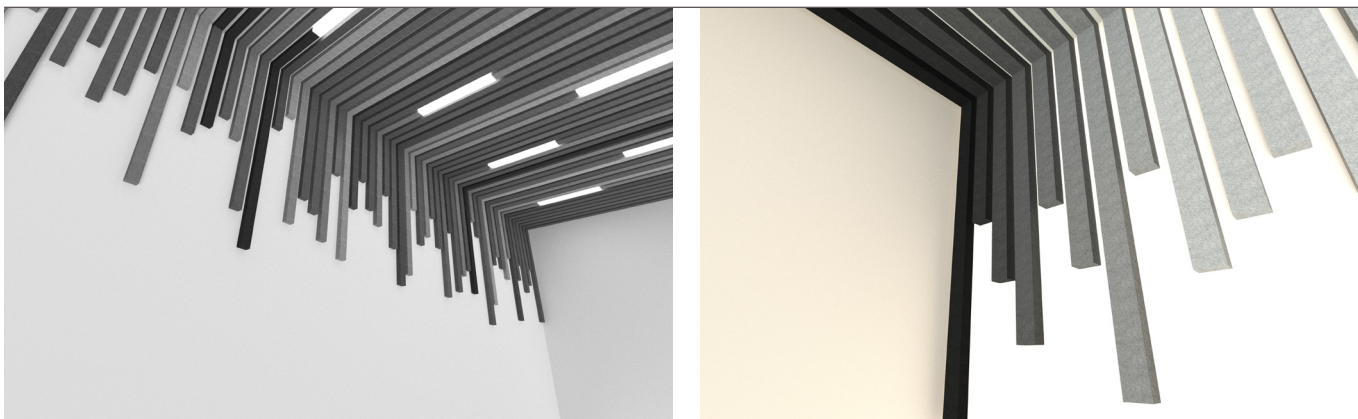

# ECOFELT

## PET FELT ACOUSTIC PANELS

### BAFFLES SYSTEM

CURVED BAFFLES

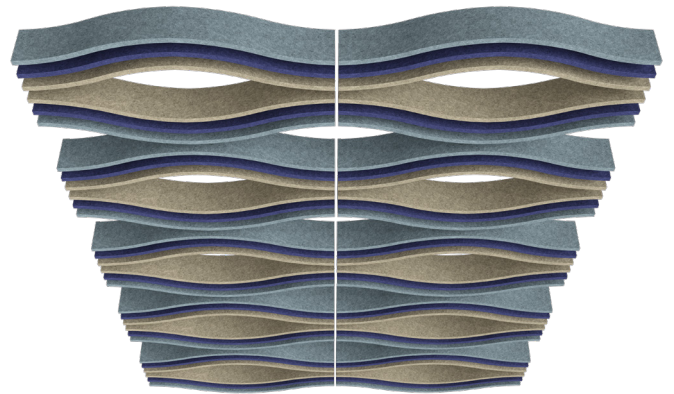
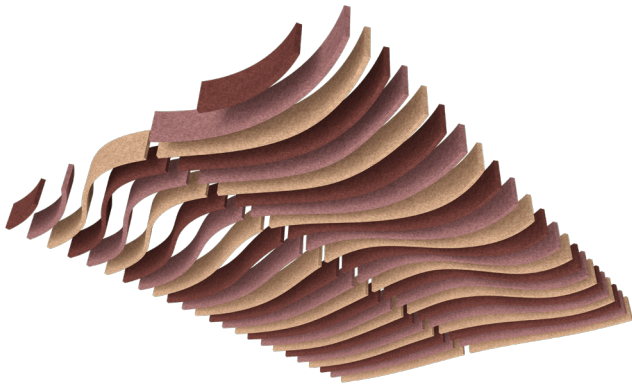
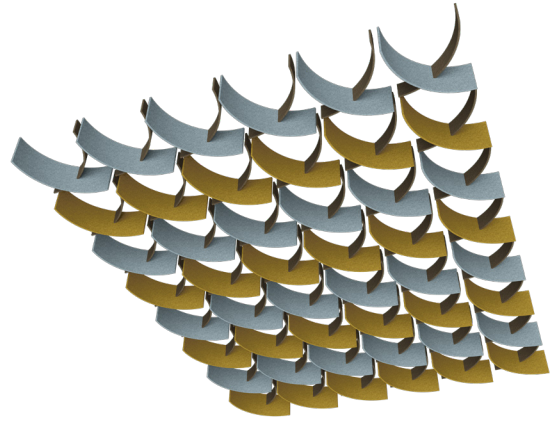
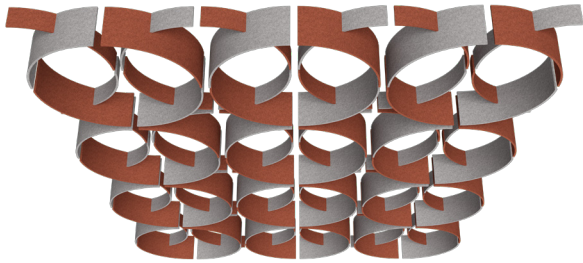

# ECOFELT

## PET FELT ACOUSTIC PANELS

### BAFFLES SYSTEM



GROUPED CLUSTERED BAFFLES

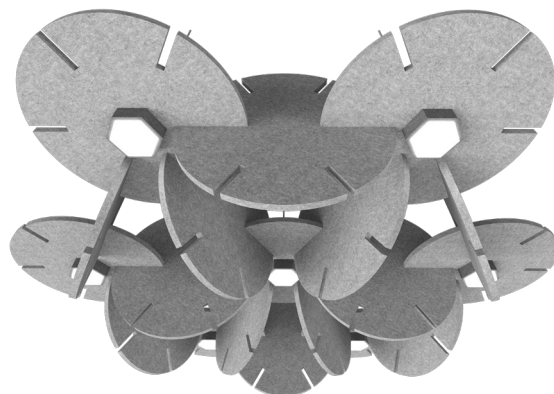
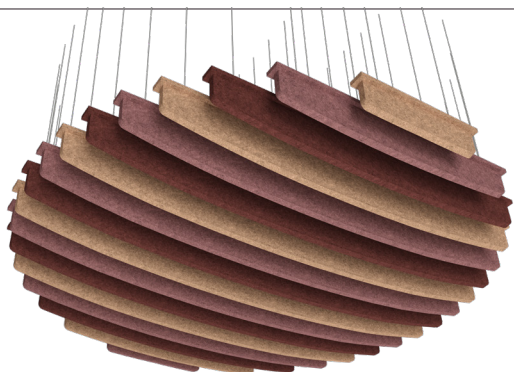

# ECOFELT

## PET FELT ACOUSTIC PANELS

### BAFFLES SYSTEM

#### QUADRA BAFFLES

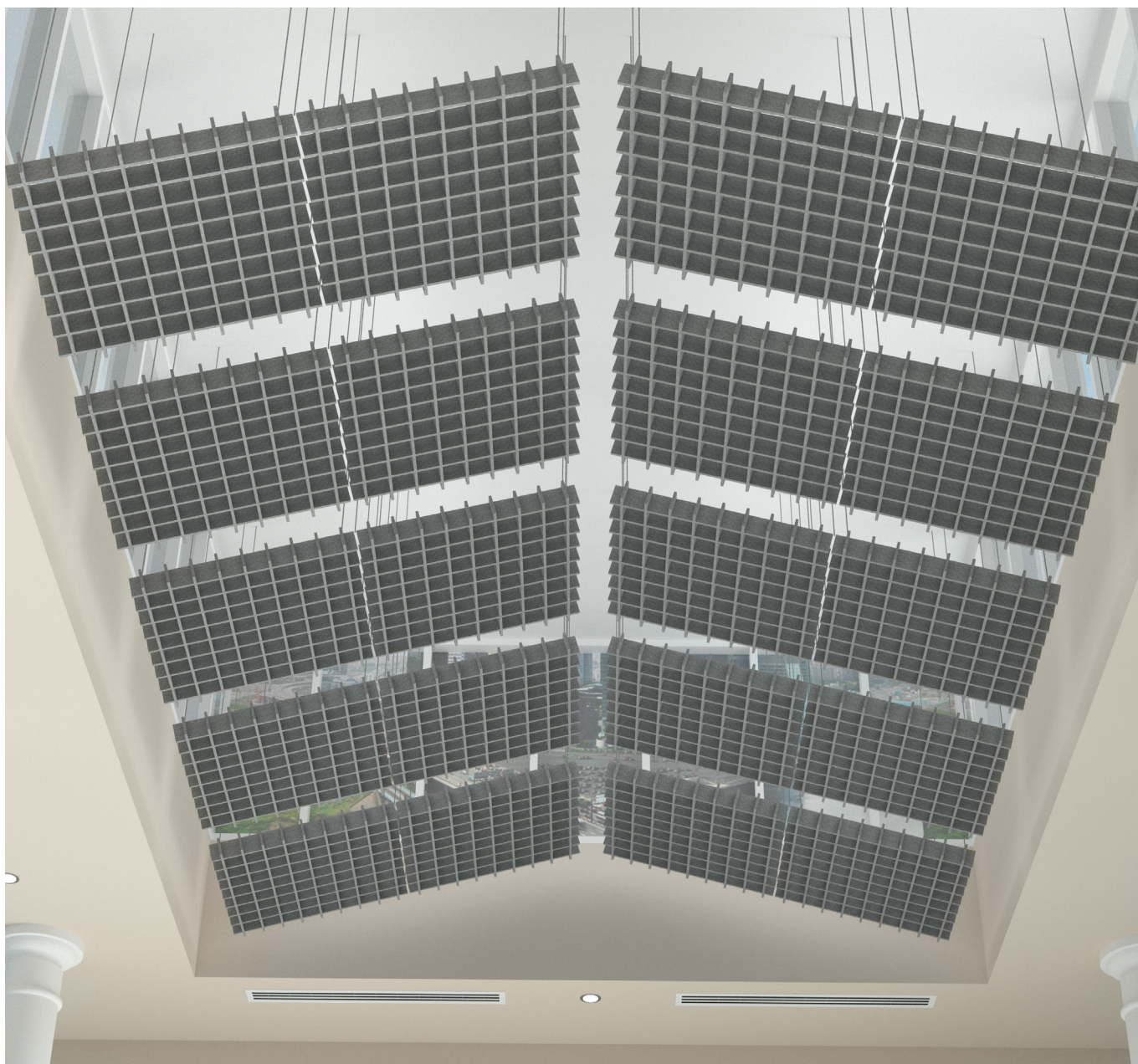
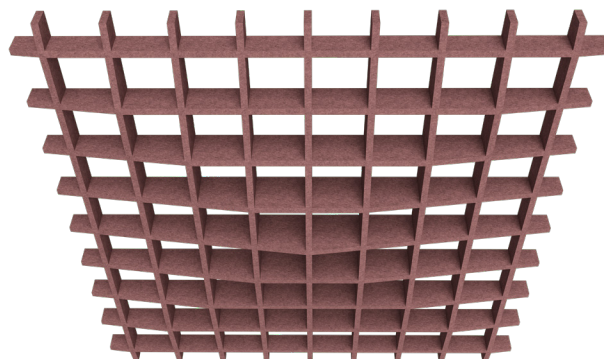

# ECOFELT

## PET FELT ACOUSTIC PANELS

### BAFFLES SYSTEM



#### CROSSING BAFFLES

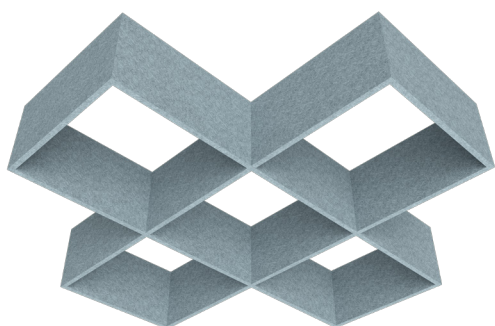
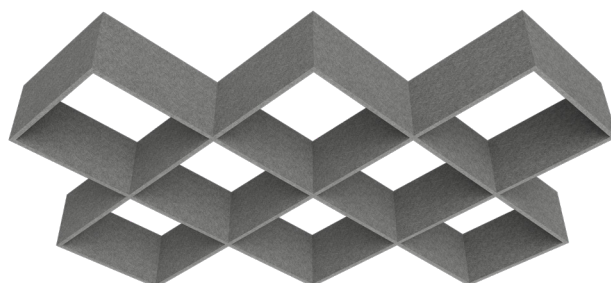
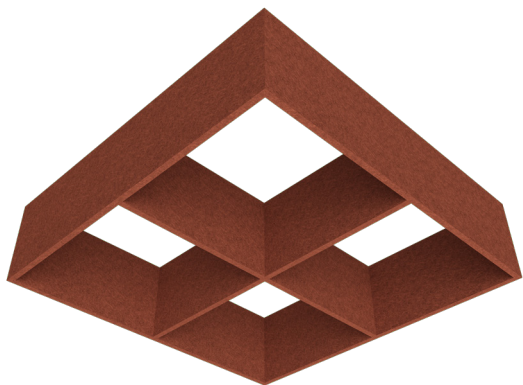

# ECOFELT

## PET FELT ACOUSTIC PANELS

### BAFFLES SYSTEM

CLOUD BAFFLES

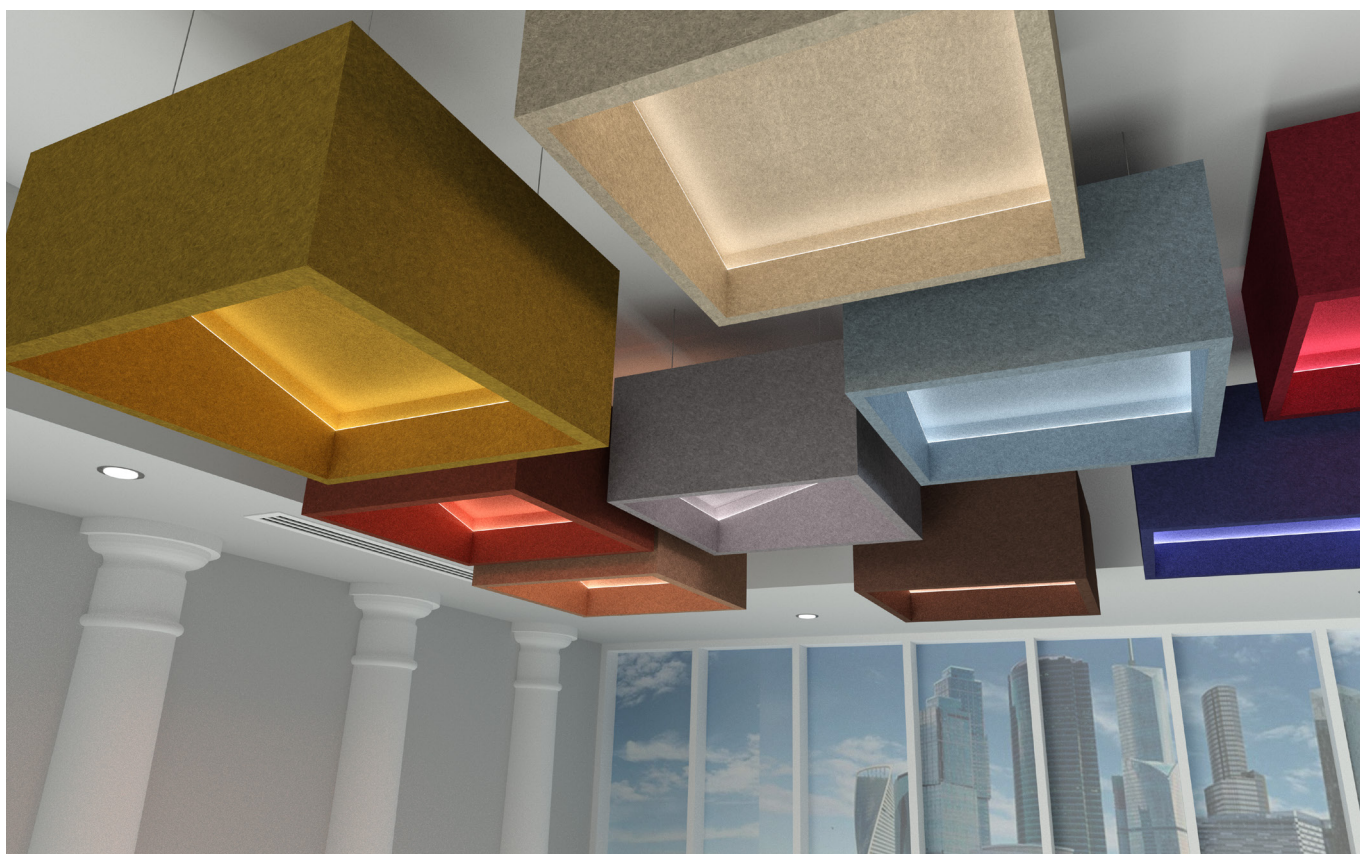
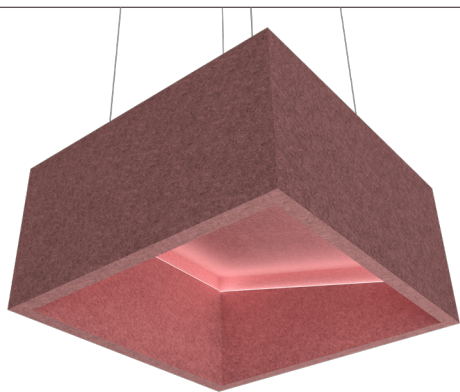
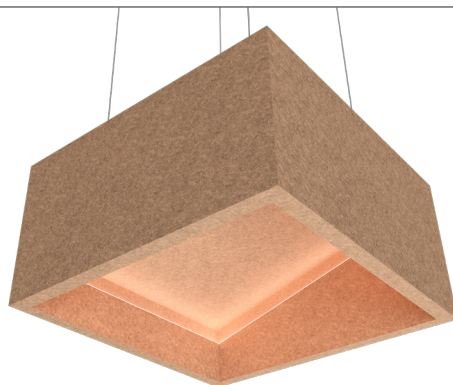
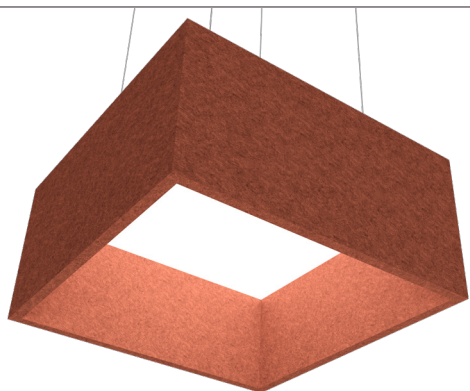

# ECOFELT

## PET FELT ACOUSTIC PANELS

### PETWAVES SYSTEM



#### SYSTEMS CONFIGURATIONS\*

PETWAVES SQ EDGE

PETWAVES SL EDGE

PETWAVES FL EDGE



PLAN

SECTION

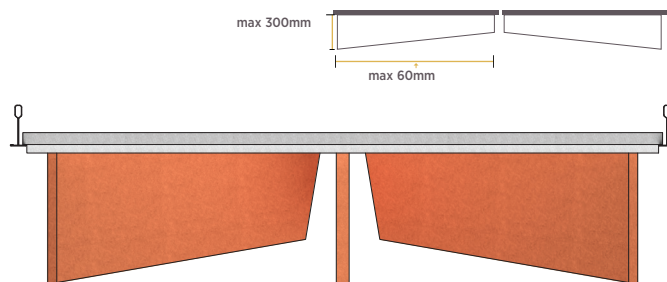
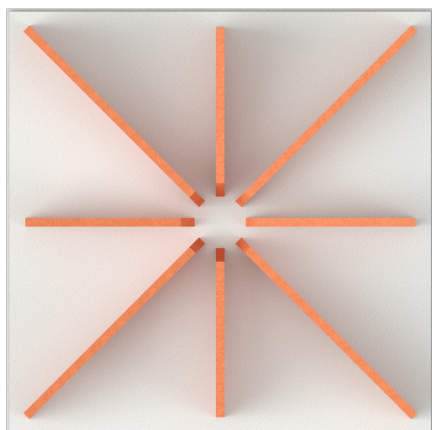

GRID SYSTEM

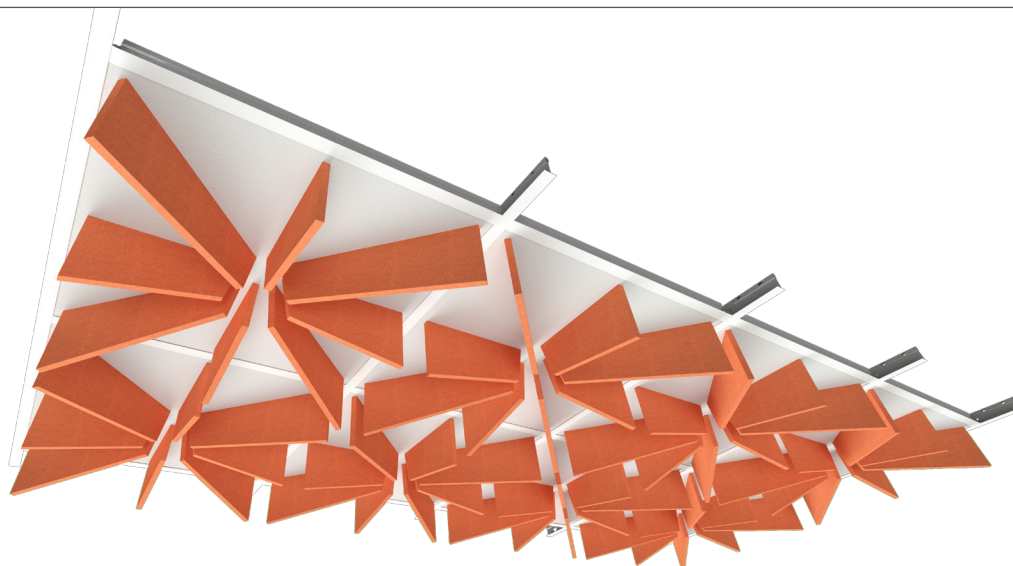

\* Refer to USG Middle East technical team for the size limitation and suspension accessories. Other configurations are available upon request.

# ECOFELT

## PET FELT ACOUSTIC PANELS

### PETWAVES SYSTEM

#### SYSTEMS CONFIGURATIONS\*

PETWAVES SQ EDGE

PETWAVES SL EDGE

PETWAVES FL EDGE

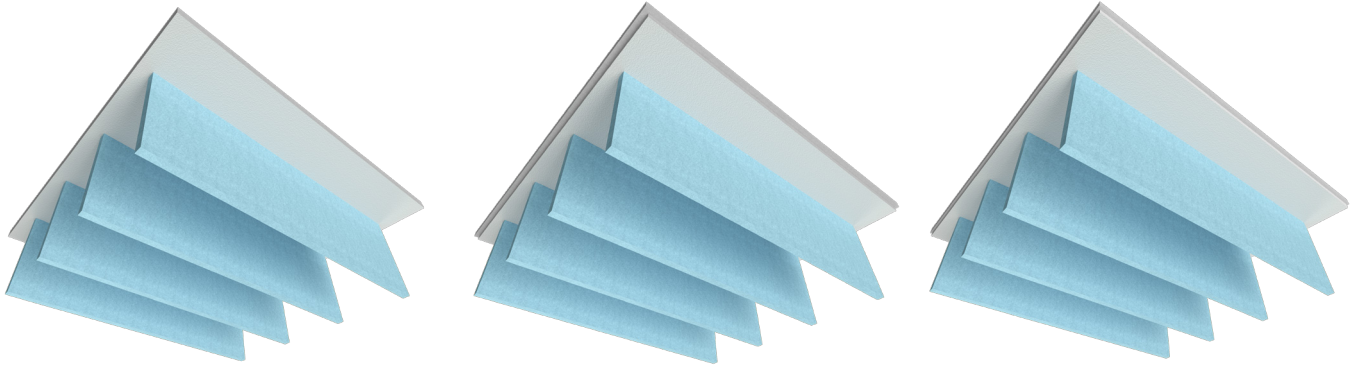

PLAN

SECTION

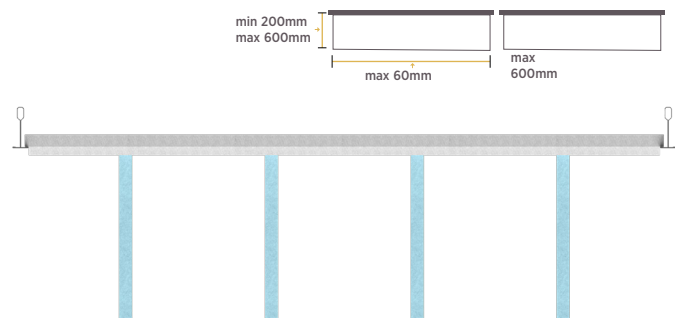
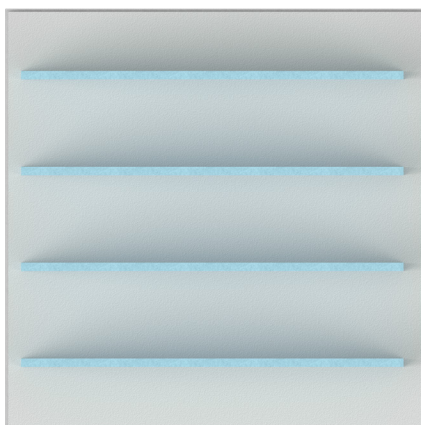

#### GRID SYSTEM

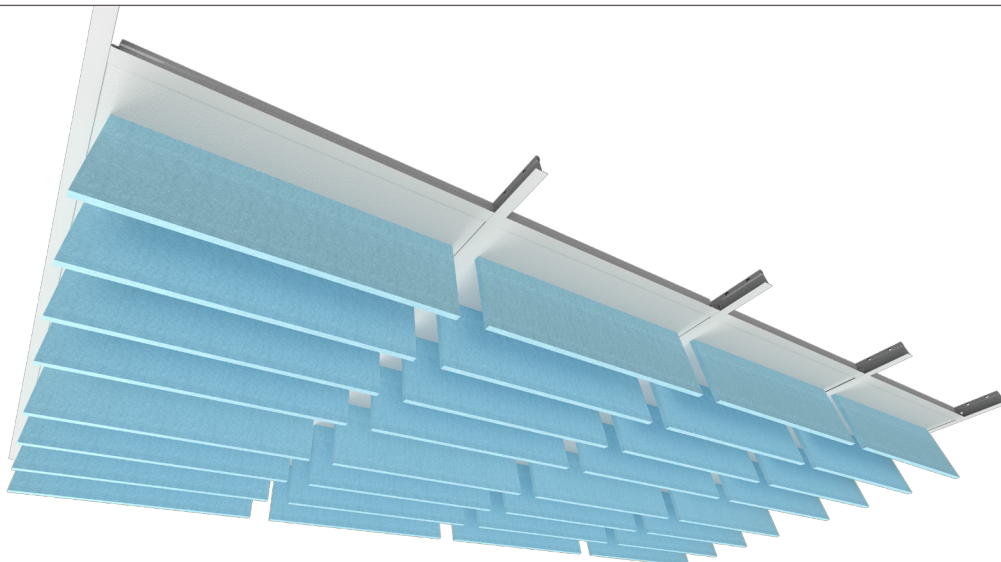

\* Refer to USG Middle East technical team for the size limitation and suspension accessories. Other configurations are available upon request.

# ECOFELT

## PET FELT ACOUSTIC PANELS

### PETWAVES SYSTEM



#### SYSTEMS CONFIGURATIONS\*

PETWAVES SQ EDGE

PETWAVES SL EDGE

PETWAVES FL EDGE

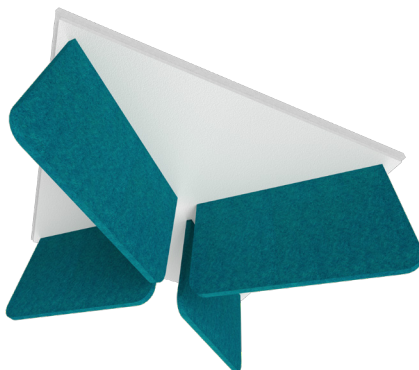
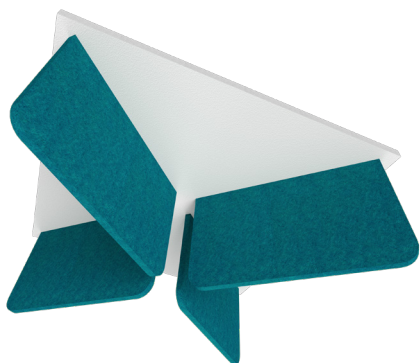

PLAN

SECTION

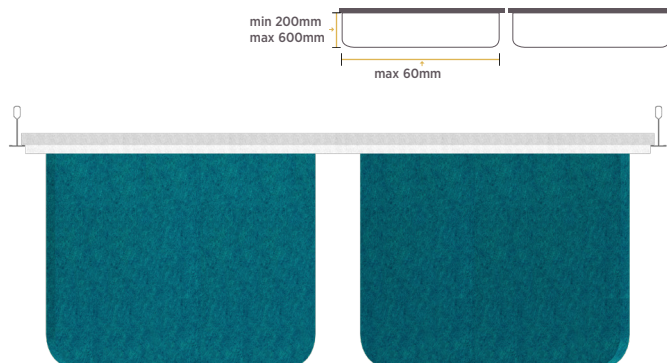
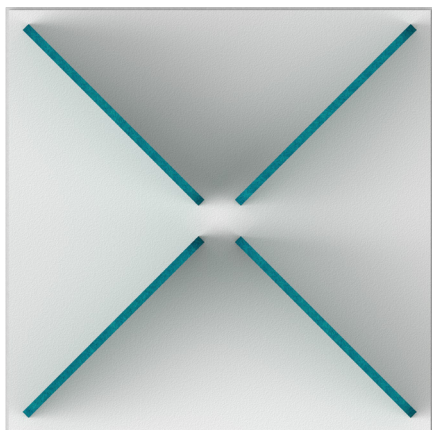

#### GRID SYSTEM

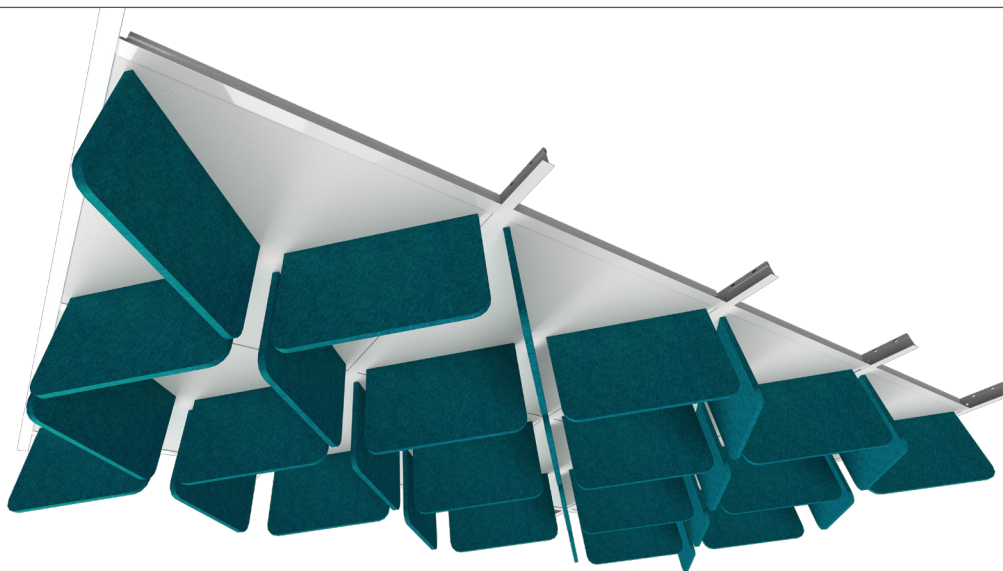

\* Refer to USG Middle East technical team for the size limitation and suspension accessories. Other configurations are available upon request.

# ECOFELT

## PET FELT ACOUSTIC PANELS

### PETWAVES SYSTEM

#### SYSTEMS CONFIGURATIONS\*

PETWAVES SQ EDGE

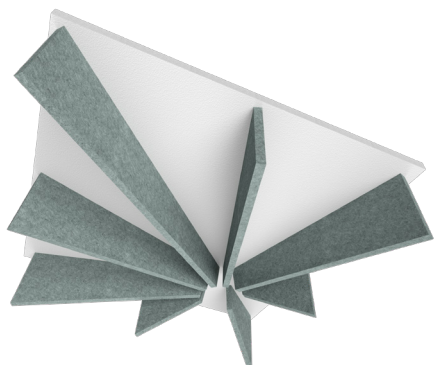

PETWAVES SL EDGE



PETWAVES FL EDGE



PLAN

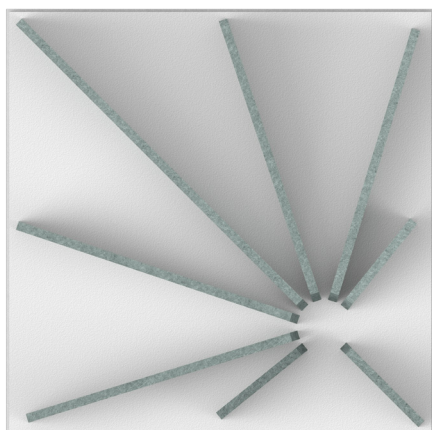

SECTION

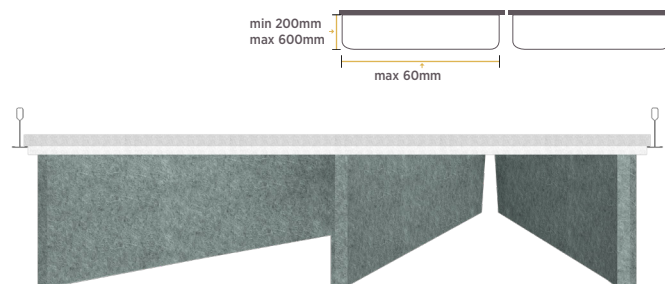

GRID SYSTEM

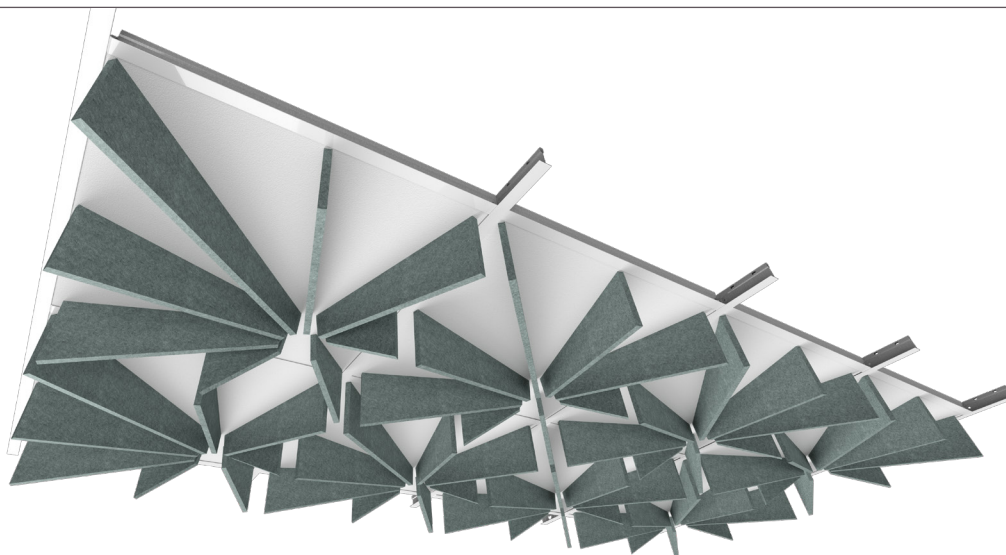

\* Refer to USG Middle East technical team for the size limitation and suspension accessories. Other configurations are available upon request.

# ECOFELT

## PET FELT ACOUSTIC PANELS

### WALL SYSTEM



FORMATION WALL

CREATIVE PERFORATION

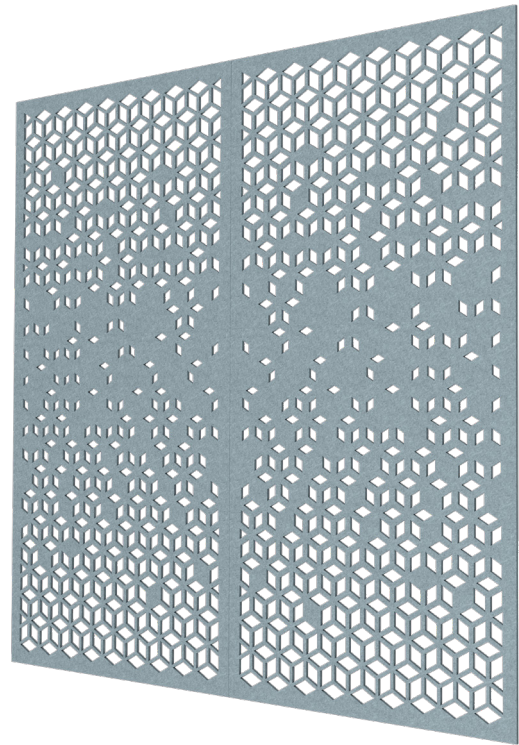
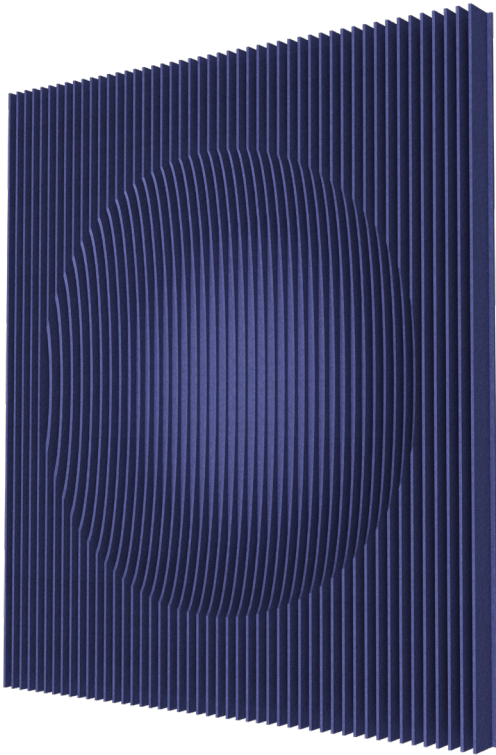

# ECOFELT

## PET FELT ACOUSTIC PANELS

### WALL SYSTEM

FRACTURE

TILE SHAPES

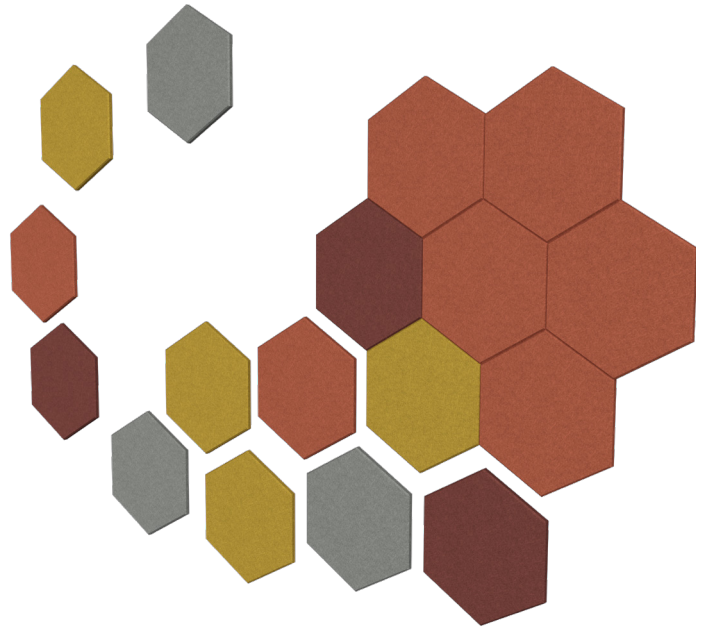
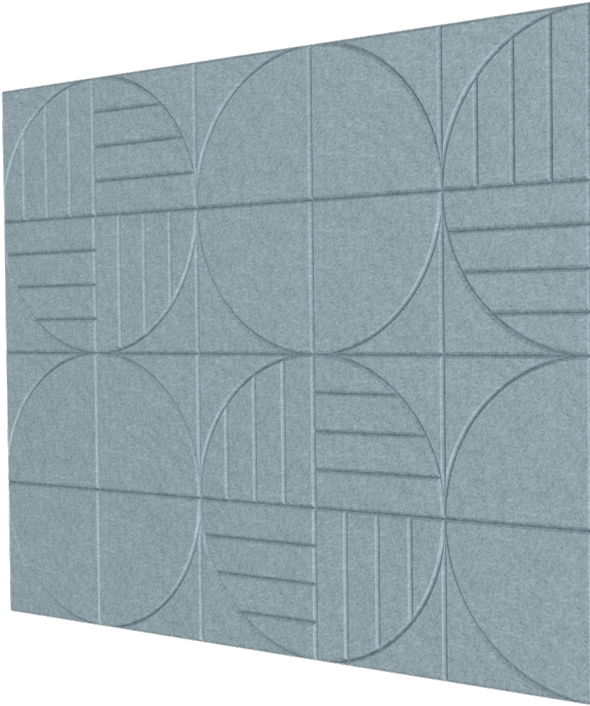

# ECOFELT

## PET FELT ACOUSTIC PANELS



*A WIDE COLLECTION*  
**OF COLORS**

# NATURAL COLORS



*Printed colors may vary from the original. Always refer to actual samples.*

# USG ME'S HANDBOOKS TO ARCHITECTS AND BUILDERS



## DOWNLOAD OUR HEALTHCARE ARCHITECTURAL HANDBOOK



A vital resource for designers and contractors, this Healthcare Architectural Handbook follows 2018 FGI Guidelines, offering complete ceilings and wall solutions for healthcare facility spaces.

## DOWNLOAD OUR CINEMA & THEATER ARCHITECTURAL HANDBOOK

A guide for developers, designers and contractors, the Cinema & Theater Architectural Handbook adheres to the latest industry standards, with solutions, case studies, and references. USG ME leads in Cinema & Theater acoustic systems.



## DOWNLOAD OUR HOSPITALITY, HOTELS AND RESORTS ARCHITECTURAL HANDBOOK



A comprehensive guide for interior designers, architects, and fit-out contractors, this Hospitality Architectural Handbook details hotel types, acoustic requirements, and design solutions for seamless project implementation.



## DOWNLOAD OUR EDUCATIONAL FACILITIES ARCHITECTURAL HANDBOOK

This handbook empowers architects and contractors to create inspiring, safe, and functional educational spaces. Focused on acoustical, fire, and safety design, it offers practical guidance for diverse learning environments.

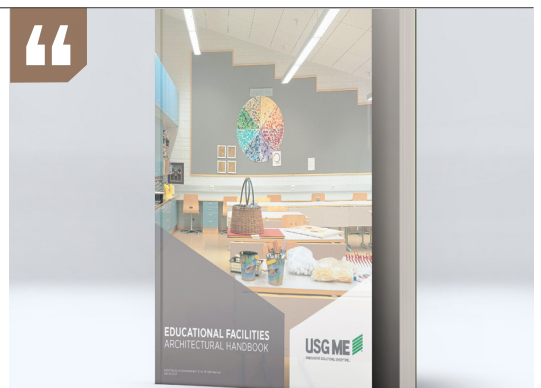

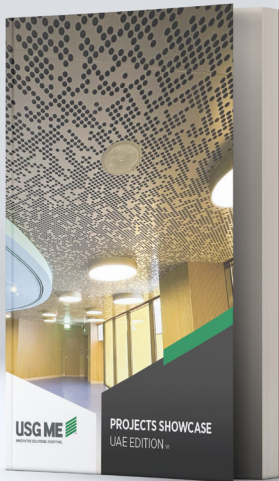

### DOWNLOAD OUR PROJECTS SHOWCASE UAE EDITION



Unveiling our debut Projects Showcase UAE Edition, spotlighting 30+ iconic projects and showcasing our prestigious contributions in the UAE. Anticipate the upcoming KSA edition for more revelations.

# OUR LATEST EDITION



### DOWNLOAD THE CEILINGS MAGAZINE

At the top of design possibilities, USG ME presents a spiritual range of ceiling solutions. Our product line, spanning acoustical panels, specialty designs, integrated ceilings, and suspension systems, envisions flexible design, effortless installation, and stellar performance.



# You Can Find Us On Social Media



SEE US ON LINKEDIN  
[/usgme](#)



FIND US ON FACEBOOK  
[/usgme](#)



FOLLOW US ON INSTAGRAM  
[/usg\\_me](#)



FOLLOW US ON X  
[/usg\\_me](#)



SEE US ON YOUTUBE  
[/USG Middle East](#)



MESSAGE US ON WHATSAPP  
[/+966 92 003 5672](#)



**FACTORY OF USG MIDDLE EAST LTD. CO.**  
7410 (Wasil), Street #23, Cross 76,  
2<sup>nd</sup> Industrial City, Dammam 34326-4201,  
Kingdom of Saudi Arabia

**CUSTOMER SERVICE**  
t +966 13 812 0995  
f +966 13 812 1029  
[info@usgme.com](mailto:info@usgme.com)

**WEBSITE**  
[www.usgme.com](http://www.usgme.com)



**WHATSAPP**  
[+966 92 003 5672](https://wa.me/966920035672)

